



Shanghai AIYIA Steel

Professional Steel Supplier





Shanghai AIYIA Industrial Co., Ltd.

Shanghai AIYIA Industrial Co., Ltd. is a professional steel raw material supplier, located in Shanghai, the economic center of China. We supply various steel products, which are widely used in construction, industry, agriculture, food packaging and other fields. Our products are galvanized steel coil, galvalume steel coil, SuperDyma, PPGI, PPGL, cold rolled steel coil, stainless steel coil, tinplate, tin free steel, roofing sheets, spring steel strip and various special steel sheets, our product shapes are coils, sheets, plates, rods, pipes, angle, etc. We rely on China's excellent export ports to export products to all parts of the world. Our export ports include Shanghai, Qingdao, Ningbo, Tianjin, Qinhuangdao, etc. Since the establishment of AIYIA, our products have been exported to dozens of countries around the world, it exported to Europe, Africa, Southeast Asia, Middle East, Russia, America, Australia. Our products strongly support local economic development. Our production equipment is advanced, our management is scientific and reasonable, we strictly inspect the quality, our products are reasonably priced, we have stable supply, fast delivery and responsible after-sales service, so our products are widely praised. We strictly abide by the principles of "integrity", "quality", and "win-win" to treat every customer friend. If you have purchasing requirements, welcome to China, welcome to AIYIA!





Products

Hot-Dip Galvanized Steel Coil

Electro Galvanized Steel Coil

Hot-Dip Galvalume Steel Coil

SuperDyma Steel Coil

PPGI & PPGL

Cold Rolled Steel

Roofing Sheet





Why Choose Us ?



Advanced Equipment

40000m² factory area, several acid pickling, galvanizing and color coating production lines, international advanced level.

Capacity Of Production

The total monthly output is 30,000 tons, which can meet the mass demand of customers. In addition, it can process steel plates, steel pipes, steel belts and other products.



Quality Inspection

We implement a strict quality inspection system to ensure that every batch of products are of high quality and up to standard.

Transportation

Our products are shipped from Qingdao, Tianjin, Shanghai and other large ports. Our products are exported to the global market.





Quality Certification



About Product Transportation



We offer different shipping methods depending on the customer's destination: rail transport and ship transport. The shipping mark shall consist of: trade mark, seller's name, product name, application cable standards, specifications, packing number, contract number, heat number, color, production date, weighing method, net weight, gross weight, consignee and protection symbols, etc.

Global Market



We are committed to explore the international market. Our customers come from all over the world, such as Africa, Latin America, Middle East, Southeast Asia, Europe, etc. Our high quality and low price products have won their recognition.



Hot-Dip Galvanized Steel Coil

Hot-dip galvanizing is the reaction of molten metal with an iron substrate to produce an alloy layer, thereby combining the substrate and the plating layer. Hot-dip galvanizing is to pickle iron and steel parts first. In order to remove iron oxide on the surface of iron and steel parts, after pickling, it is cleaned in an ammonium chloride or zinc chloride aqueous solution or a mixed solution of ammonium chloride and zinc chloride. And then sent to the hot-dip plating bath. Hot-dip galvanizing has the advantages of uniform coating, strong adhesion and long service life.





Specifications

Thickness & Tolerance: 0.12-6.00mm(+0/-0.001mm), or customized as required

Width & Tolerance: 600-1500 mm(+/-0.06mm), or customized as required

Zinc Coating: 20-275g/m², or customized as required

Spangle: Normal Spangle coating(NS)/Minimized Spangle coating(MS)/Spangle-Free(FS)

Surface Treatment: Anti-Finger printing/Chromated/Oiled/Non-Oiled

Steel Grade: Dx51D / Dx52D / Dx53D / DX54D / S220GD / S250GD / S280GD / S350GD / S350GD / S550GD; SGCC / SGHC, SGCH, SGH340, SGH400, SGH440, SGH490, SGH540, SGCD1, SGCD2, SGCD3, SGC340, SGC340 , SGC490, SGC570; SQ CR22 (230), SQ CR22 (255), SQ CR40 (275), SQ CR50 (340), SQ CR80 (550), CQ, FS, DDS, EDDS, SQ CR33 (230), SQ CR37 (255), SQCR40 (275), SQ CR50 (340), SQ CR80 (550); or Customer's Requirement

Layer Schematic

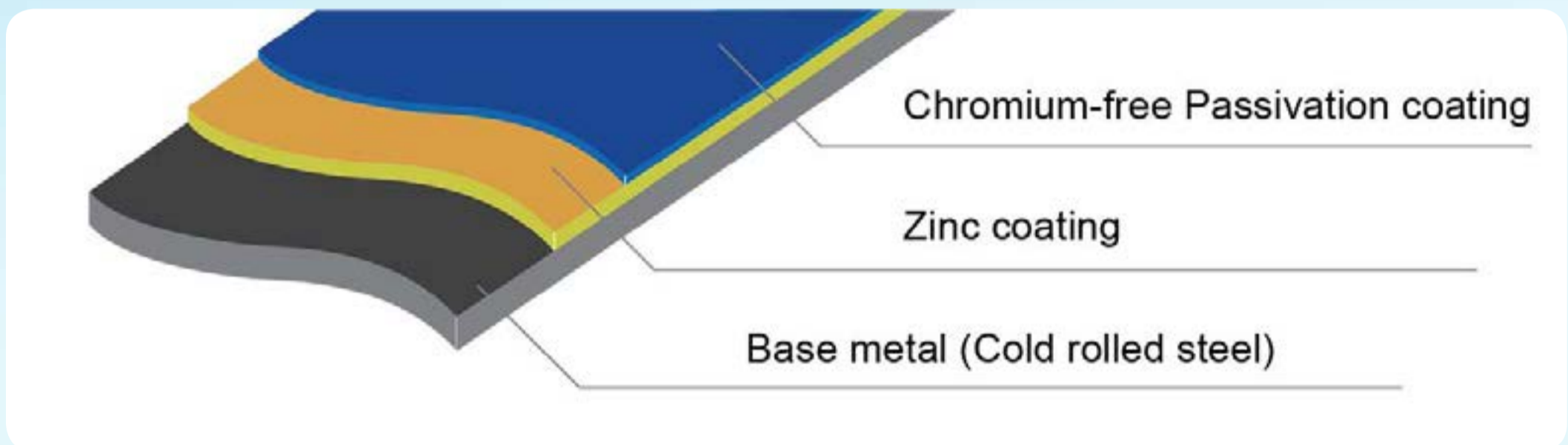

Production Process

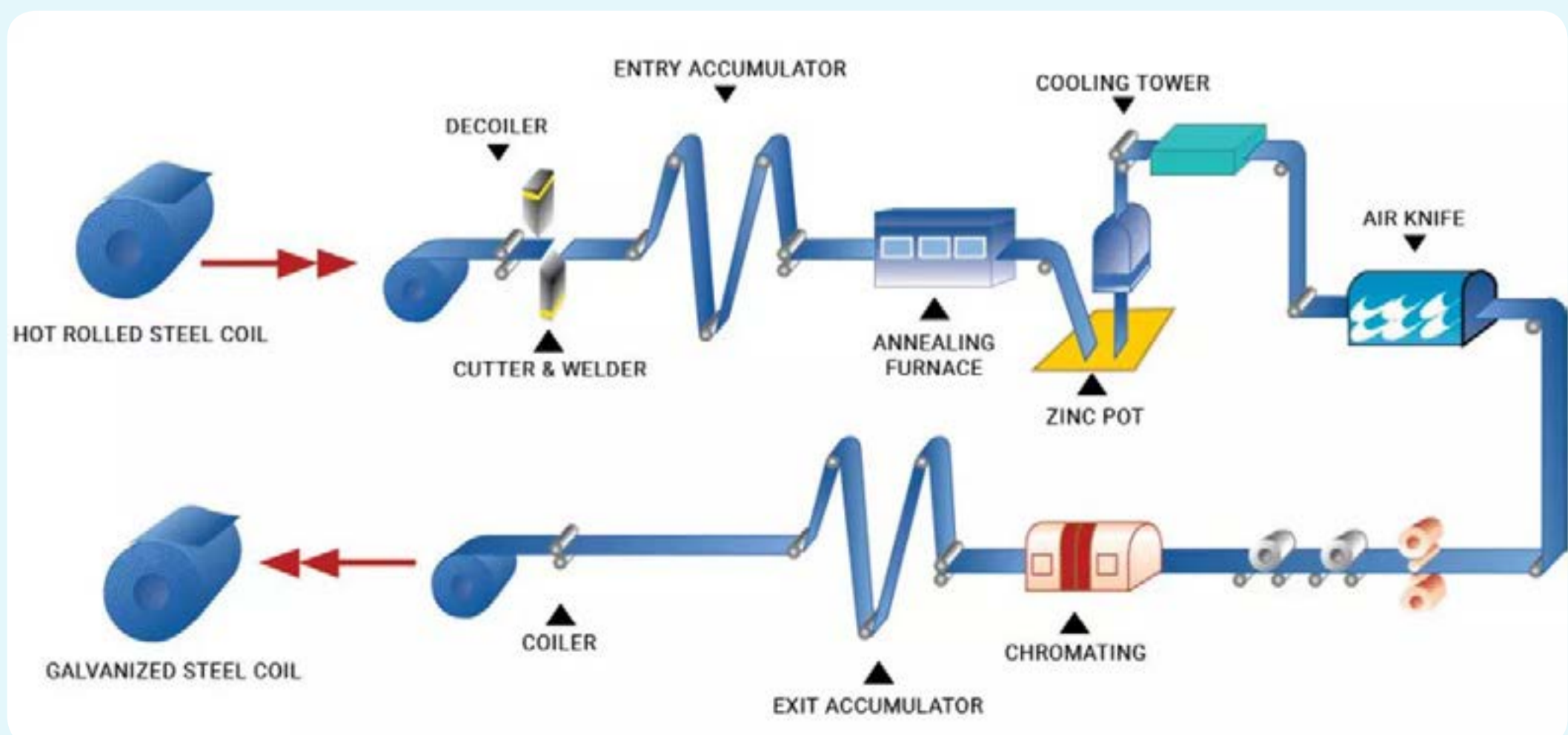



Surface Structure

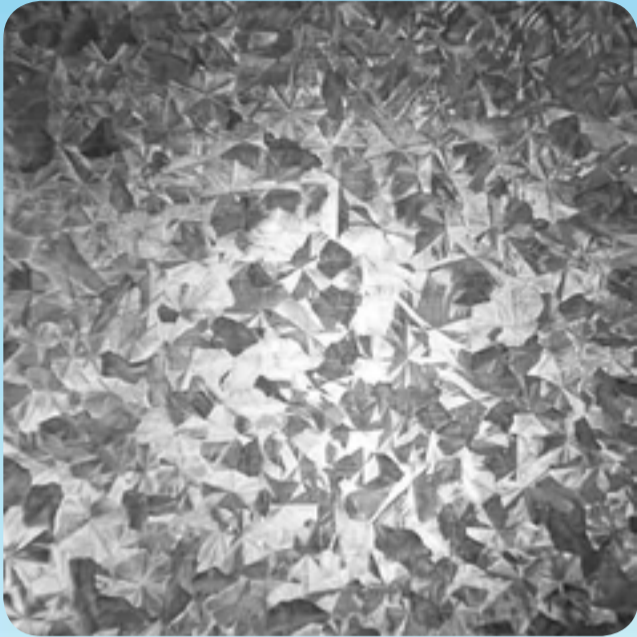

①

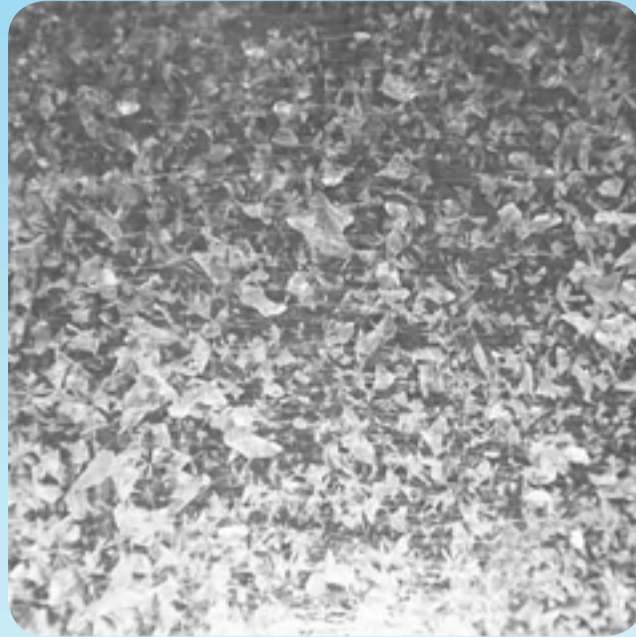

②



③

① **Normal spangle:** Through addition of certain heavy metal element into molten zinc bath, regular spangle pattern is produced on hot-dip zinc-coated steel sheet.

② **Minimized spangle:** The zinc layer does not contain lead, which complies with EU WEEE and ROHS directives. This is a non-toxic and environmental friendly material.

③ **Spangle-free:** During hot-dip galvanizing, only a certain amount of aluminum is added to the zinc solution, and lead-free, antimony, and tin are not added to produce spangle-free products.

Advantage

1.Anticorrosive: 13 years in heavy industrial areas,50 years in the ocean,104 years in the suburbs and 30 years in cities.

2.Cheap: The cost of hot-dip galvanizing is lower than that of other coatings.

3.Reliable: The zinc coating is metallurgically bonded to the steel and forms part of the steel surface,so the coating is more durable.

4.Strong toughness: The galvanized layer forms a special metallurgical structure that can withstand mechanical damage during transportation and use.

5.Comprehensive protection: Every part of the plated piece can be galvanized,and is fully protected even in depressions,sharp corners,and hidden places.

6.Save time and energy: Galvanizing process is faster than other coating methods.



Electro Galvanized Steel Coil

Electro-galvanizing is a process in which a layer of zinc is bonded to steel in order to protect against corrosion. Electro-galvanizing is a process in which a layer of zinc is bonded to steel in order to protect against corrosion. Electrogalvanized sheet is manufactured by electroplating a pure zinc coating on one or two sides of carbon steel sheet. This continuous electrolytic coating process can be used to apply the coating onto the surface of the steel sheet with an exceptionally uniform thickness.



Specifications

Standard: AISI, ASTM, BS, DIN, GB, JIS

Thicknesses: 0.4-3.0 mm

Width: 600-1800 mm

Zinc Coating: 40g/m²

Grade: EN10152/DC01+ZE/DC03+ZE/DC04+ZE/DC05+ZE/DC06+ZE/DC07+ZE

Advantages

1. Good corrosion resistance, fine and uniform combination, not easy to be corrosive gas or liquid into the interior.
2. Because zinc layer is relatively pure, it is not easy to be corroded in acid or alkali environment. Protect the steel body effectively for a long time.
3. After chromic acid passivation, it can be used in various colors. It can be selected according to customers' preference. The galvanizing is beautiful and decorative.
4. After chromic acid passivation, it can be used in various colors. It can be selected according to customers' preference. The galvanizing is beautiful and decorative.



Hot-Dip Galvalume Steel Coil

Galvalume steel is also called Aluminum-Zinc Alloy Coated Steel, aluminized zinc steel (aluzinc steel), SGLC, the galvalume metal is composed of 55% aluminium, 43.4% zinc and 1.6% silicon solidified at 600 °C. Its whole structure consists of aluminium-iron-silicon-zinc, forming a compact quaternary crystal alloy. The surface of the galvalume steel sheet is characterized by smooth, flat and gorgeous stars, and its base color is silver white. The special coating structure makes it have excellent corrosion resistance. The normal service life of galvalume steel sheet is up to 25a, and its heat resistance is good. It can be used in high temperature environment at 315°C. The adhesion between coating and paint film is good, and it has good processing performance. It can be punched, sheared and welded. The surface conductivity is very good.

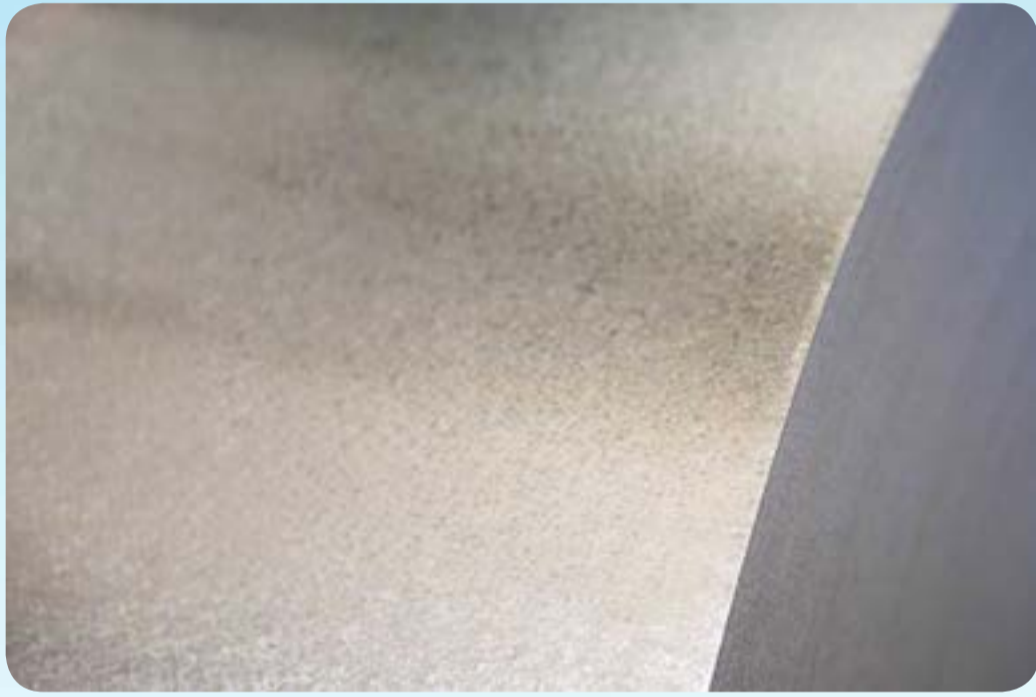



Specifications

Standard: EN/DIN/JIS/ASTM

Thickness & Tolerance: 0.12-6.00mm(+0/-0.001mm), or customized as required

Width & Tolerance: 600-1500 mm(+/-0.06mm), or customized as required

Al-Zn coating: 30/30g/m²-90/90g/m²(30/30, 40/40, 50/50, 60/60, 75/75, 90/90) Or customized

Brand: AIYIA

Surface Treatment: Chromate passivated, Non-chromate passivated, Chromate passivated + oiling, Non-chromate passivated+oiling, Anti-fingerprint, Non-chromate anti-fingerprint treatment, Oiling, No treatment

Spangle: Normal (non-skinpassed) spangle, Skinpassed spangle, Regular spangle, Minimized spangle

Steel Grade: DC51D+AZ, DC52D+AZ, DC54D+AZ, DC53D+AZ, S250GD+AZ, S300GD+AZ, S350GD+AZ, S450GD+AZ, S550GD+AZ

Layer Schematic

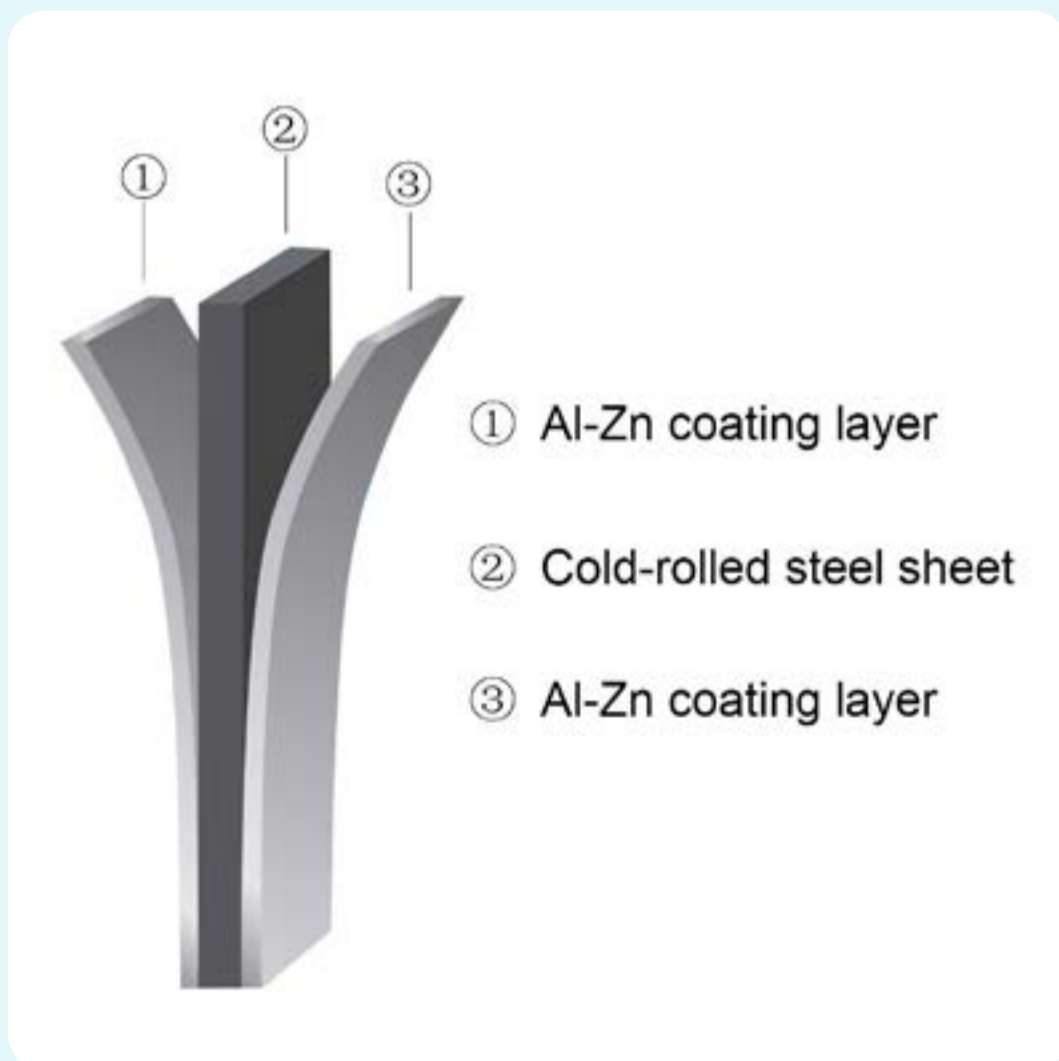

Normal (non-skinpassed) spangle



Skinpassed spangle



Regular spangle



Minimized spangle



Production Process

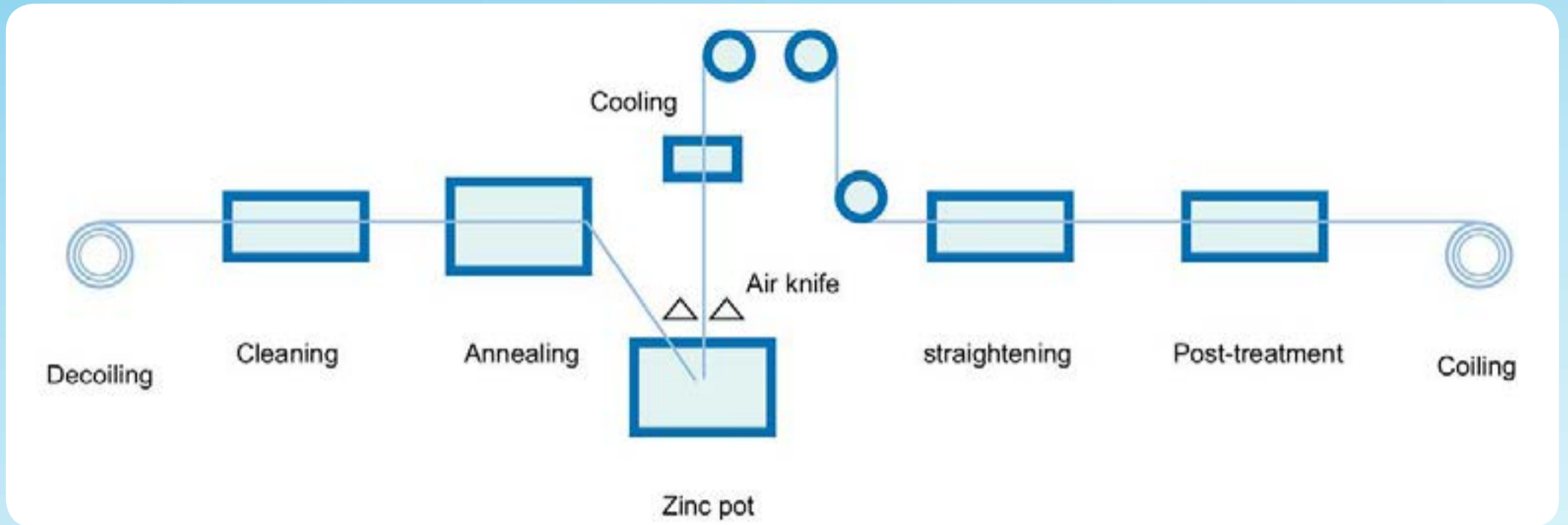

Advantage

- 1. Corrosion resistance:** When zinc is abraded, aluminum forms a dense layer of alumina that prevents further corrosion of the corrosive material inside.
- 2. Heat resistance:** Galvalume steel has good heat resistance and can withstand high temperatures of more than 300 degrees Celsius.
- 3. Thermal reflexes:** The heat reflectivity of Al Zn steel plate is very high, which is two times that of galvanized steel sheet.
- 4. Economical efficiency:** Since the density of 55% AL-Zn is smaller than the density of Zn, the aluzinc steel sheet is more than 3% larger than the area of the plated steel sheet when the weight is the same and the thickness of the gold-plated layer is the same.

Application

Construction: roofs, garages, walls, fences, ventilation ducts, sewers, and modular houses

Automotive: muffler, exhaust pipe, wiper accessories, fuel tank, truck box, etc.

Home appliances: refrigerator back plate, gas stove, air conditioner, electronic microwave oven, LCD frame, CRT explosion-proof belt, LED backlight, electrical cabinet, etc.

Agricultural: pig house, chicken house, granary, greenhouse pipes, etc.

Others: thermal insulation cover, heat exchanger, dryer, warmer, etc.

Advantages of AIYIA



SuperDyma Steel Coil

SuperDyma(Al-Mg-Zn or Aluminum-Magnesium-Zinc coated steel) is a new type of highly corrosion-resistant coated steel sheet with a coating composition consisting of zinc as the main substrate in combination with aluminum (about 11%), magnesium (about 3%) and a trace amount of silicon. Adding Al, Mg, and Si to SuperDyma, the composite effect of these added elements improves corrosion resistance. Compared with hot-dip galvanized steel sheet and hot-dip galvanized-5% aluminium alloy steel sheet, SuperDyma has less adhesion but equal corrosion resistance. In addition, it can be used instead of stainless steel or aluminium sheet because of its excellent red rust resistance.





Specifications

Width: 580—1524mm

Thickness: 0.27—9.00mm

Coating thickness: 60-450g/m²

Standard: ISO, JIS, ASTM, AS EN

Surface treatment: Passivation, fingerprint resistance, oiling

Grade:

Low carbon steel: DC51D + ZM, DC52D + ZM, DC53D + ZM, etc.

Structural steel: S250GD + ZM - S550GD + ZM, etc.

Low alloy high strength steel: HC260LAD + ZM - HC340LAD + ZM, etc.

Deep drawing high strength steel: HC220YD + ZM, etc.

Duplex steel: HCT450X + ZM, HCT590X + ZM, etc.

Advantages

SuperDyma has outstanding anti-corrosion and anti-rust functions

1. Corrosion resistance that is several times greater than previous materials
2. Automatic cross-section repair
3. Superior resistance to alkaline environments

Excellent processability

1. Anti-corrosion of processed parts is not affected
2. More resistant to scratches
3. Suitable for various welding and color coating processes

More cost-effective new materials

1. No more pre-coating
2. Can replace some stainless steel and aluminum
3. Extends product life and reduces costs



PPGI & PPGL

PPGI & PPGL (pre-painted galvanized steel & pre-painted galvalume steel) also known as pre-coated steel or color coated steel coil is a product made of hot-dip galvanized steel sheet, hot-dip galvalume steel sheet, electro galvanized steel sheet, etc. After surface pretreatment (chemical degreasing and chemical conversion treatment), one or several layers of organic coating are applied on the surface, and then baked and solidified. Color-coated steel coil has light weight, beautiful appearance and good anti-corrosion performance, and can be directly processed. The color is generally divided into gray, sea blue, brick red, etc. It is mainly used in advertising, construction, decoration, home appliances, electrical appliances, Furniture industry and transportation industry. The coatings used for color-coated steel coils are based on the environment in which the resin is selected, such as polyester silicon modified polyester, polyvinyl chloride plastisol, polyvinylidene chloride, and the like.





Specifications

Standard: EN/DIN/JIS/ASTM

Thickness & Tolerance: 0.12-6.00mm(+0/-0.001mm), or customized as required

Width & Tolerance: 600-1500 mm(+/-0.06mm), or customized as required

Zinc Coating: 20-275g/m², or customized as required

Base steel: Hot dip galvanized steel / Hot dip galvalume steel / Electro galvanized steel

Surface color: RAL series, Wood pattern, Stone pattern, Mat, Camouflage pattern, flower pattern, nano, etc

Coating structure: PE/SMP/HDP/PVDF

Substrate Typee



Hot-Dip Galvanized Steel Coil

The product obtained by coating an organic coating on a hot-dip galvanized steel sheet is a hot-dip galvanized color coated sheet. In addition to the protective effect of hot-dip galvanized sheet, the organic coating on the surface also plays a role of insulation protection and rust prevention, and its service life is longer than that of hot-dip galvanized sheet.



Hot-Dip Galvalume Steel Coil

The hot-dip galvalume steel sheet (55% Al-Zn) is used as the newly coated substrate, and the corrosion resistance of the hot-dip galvalume steel sheet is 2-5 times that of the hot-dip galvanized sheet. Continuous or intermittent use at temperatures up to 490°C will not cause severe oxidation or scale formation. The ability to reflect heat and light is twice that of hot-dip galvanized steel, and the reflectivity is greater than 0.75, which is an ideal building material to save energy.

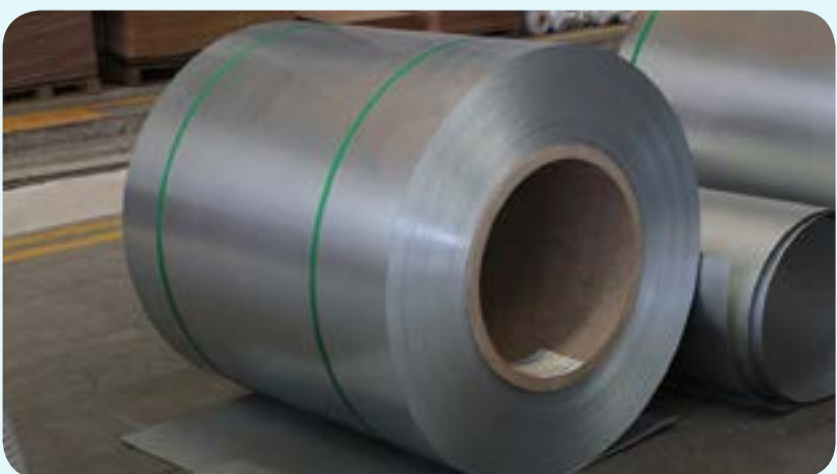

Electro Galvanized Steel Coil

The electro-galvanized sheet is used as a substrate, and the product obtained by baking with organic coating is an electro-galvanized color-coated sheet. Due to the thin zinc layer of the electro-galvanized sheet, the zinc content is usually 20 / 20g / m², so this product is not suitable for use Make walls, roofs, etc. outdoors. However, because of its beautiful appearance and excellent processing performance, it can be mainly used in home appliances, audio, steel furniture, interior decoration and so on.



Structure Diagram

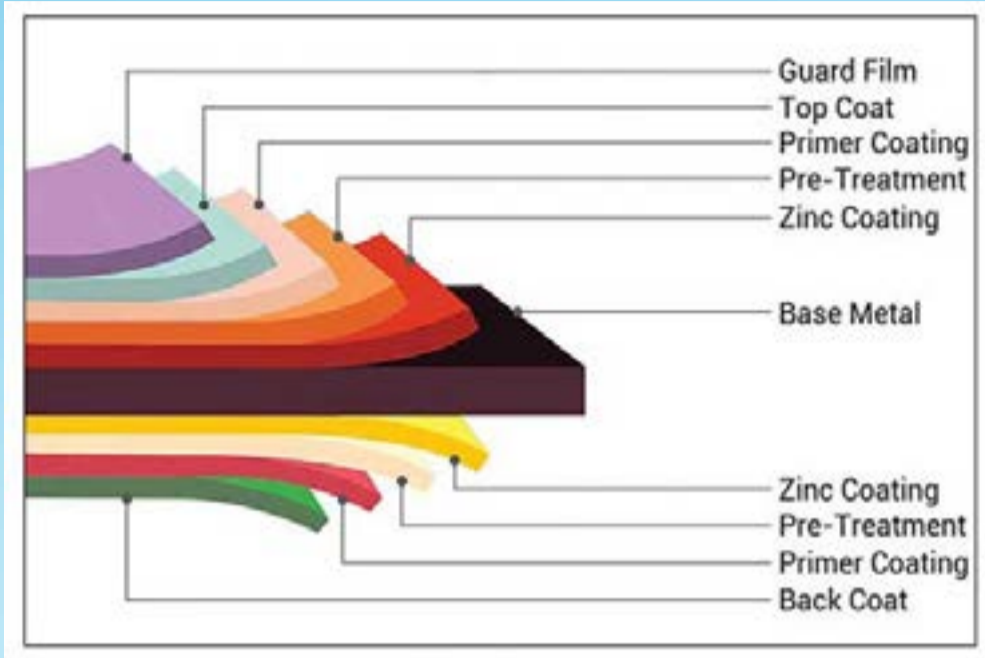

PPGI

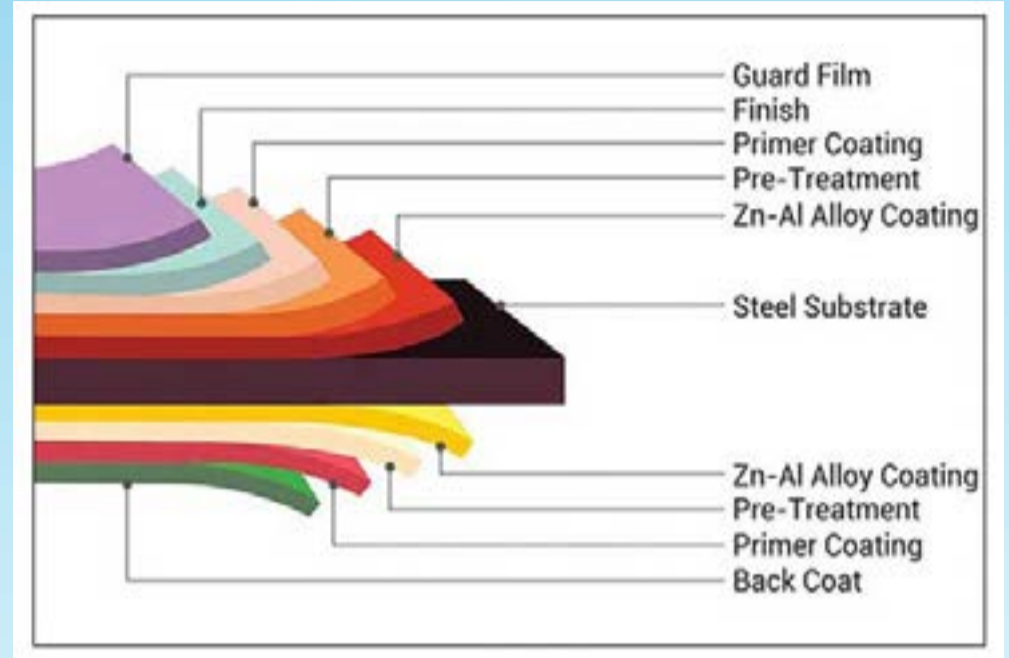

PPGL

Production Process Diagram

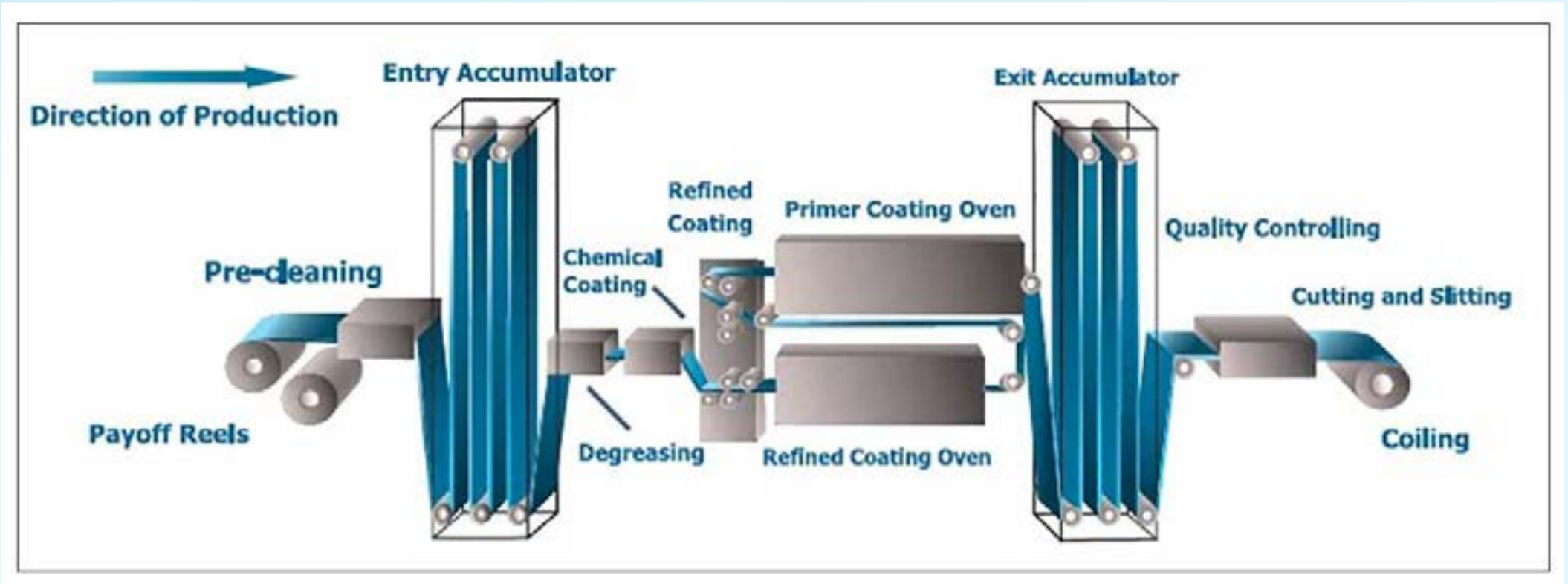

Coating Type

Polyester (PE): Good adhesion, rich colors, wide range in formability and outdoor durability, medium chemical resistance, and low cost.

Silicon Modified Polyester(SMP): Good abrasion resistance and heat resistance, as well as good external durability and chalking resistance, gloss retention, general flexibility, and medium cost.

High Durability Polyester(HDP): Excellent color retention and anti-ultraviolet performance, excellent outdoor durability and anti-pulverization, good paint film adhesion, rich color, excellent cost performance.

Polyvinylidene Fluoride(PVDF): Excellent color retention and UV resistance, excellent outdoor durability and chalking resistance, excellent solvent resistance, good moldability, stain



Cold Rolled Steel Coil

Cold rolled steel is produced by cold rolling. Cold rolling is a steel plate that further thins the No.1 steel plate to a target thickness at room temperature. Compared with hot-rolled steel sheet, cold-rolled steel sheet is more precise in thickness, smooth and beautiful in surface, and has a variety of superior mechanical properties, especially in processing performance. It is mainly used in construction, light industry, automobile, agriculture, animal husbandry, fishery and commerce. Among them, the construction industry is mainly used to manufacture anti-corrosion industrial and civil building roof panels, roof grilles, etc. The light industry uses them to make household appliances shell, civil chimneys, kitchen appliances, etc. In the automotive industry is mainly used to manufacture corrosion-resistant parts of cars, etc. Agriculture, animal husbandry and fisheries are mainly used for food storage and transportation, meat and aquatic products freezing processing equipment, and commerce is mainly used as material storage, transportation, packaging, etc.

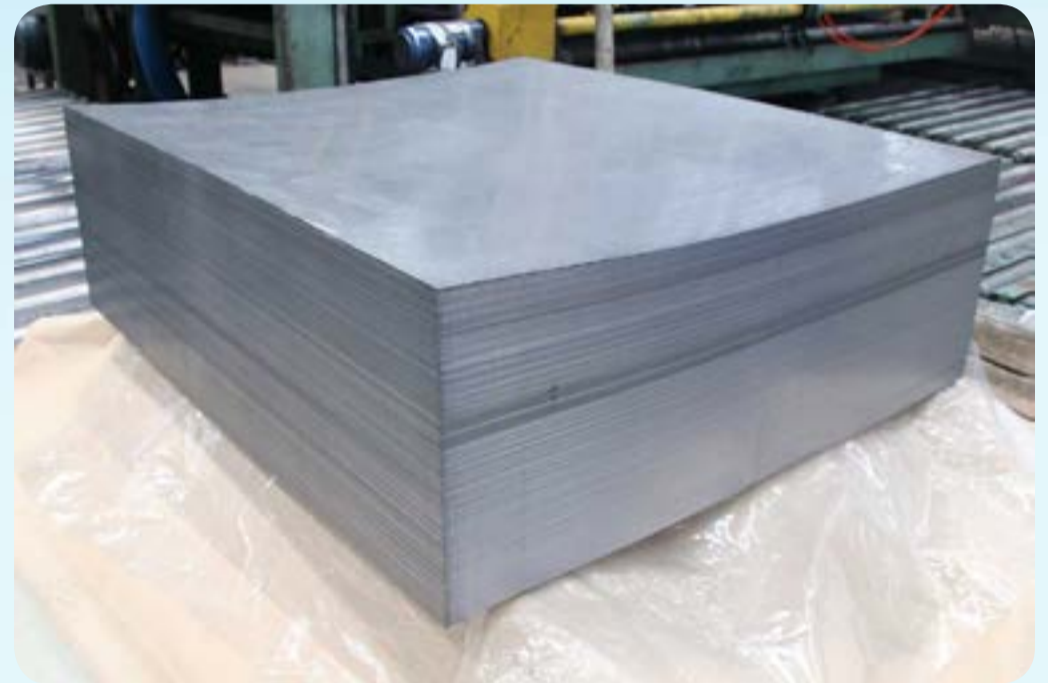



Specifications

Thickness: 0.11-5.0 mm

Width: 600-1500 mm

Hardness: Softy , half hard ,hard quality

Mechanical: Commercial / Drawing / Deep Drawing /Extra Deep Drawing/Structural quality

Grade: Q195,Q215,Q235,08AL,SPCC,SPCD,SPCE,SPCEN,ST12,ST13,ST14,ST15,ST16,DC01,DC03,DC04,DC05,DC06,etc

Advantages

- 1.The cold-rolled coil products are accurate in size, uniform in thickness, and the thickness difference of the coils generally does not exceed 0.01-0.03 mm or less, which can meet the requirements of high-precision tolerances.
- 2.It is possible to obtain extremely thin strips that cannot be produced by hot rolling (up to 0.001 mm or less).
- 3.The surface quality of cold-rolled products is superior, there are no defects such as pitting, hot-pressed iron oxide, etc., which are often found in hot-rolled coils, and coils of different surface roughness (glossy or hemp) can be produced according to user requirements. Rough surface, etc., to facilitate the processing of the next process.
- 4.The cold rolled plate has a good mechanical properties and process properties (such as higher strength, lower yield limit, good deep drawability, etc.).
- 5.High-speed rolling and full-continuous rolling can be realized with high productivity.



Roofing Sheet

Pressed corrugated steel sheet (roofing sheet) refers to the steel sheet formed by cold pressing or cold rolling. The steel sheet is made of coloured steel sheet, galvanized steel sheet, stainless steel sheet, aluminium sheet, anticorrosive steel sheet or other thin steel sheet. The profiled steel sheet has the characteristics of light weight, high strength, low price, good seismic performance, fast construction and beautiful appearance.

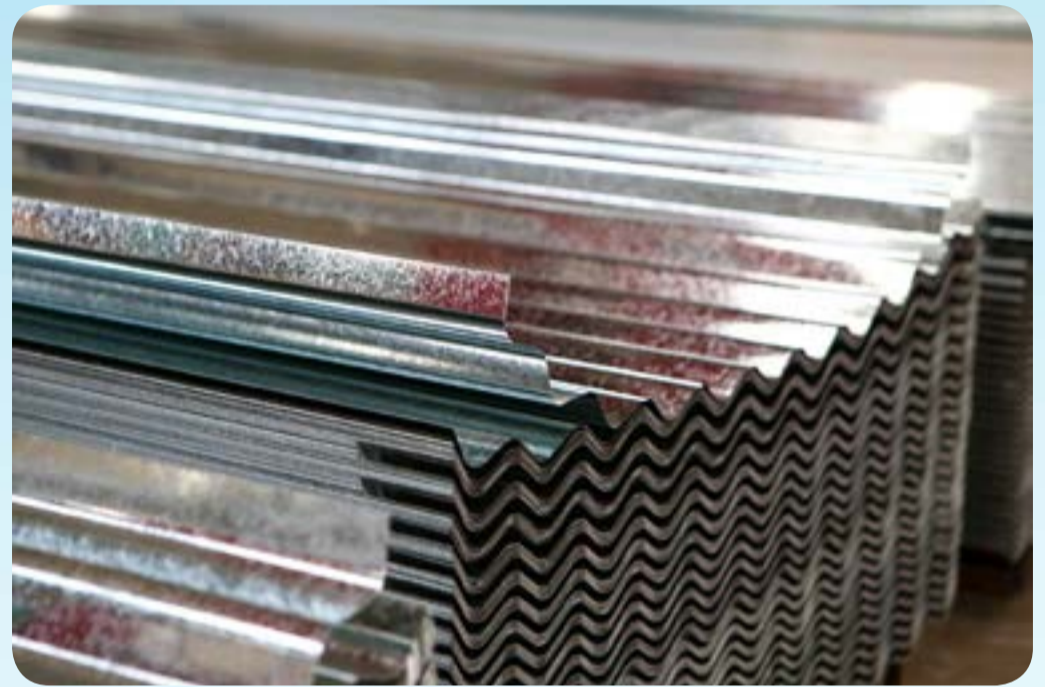
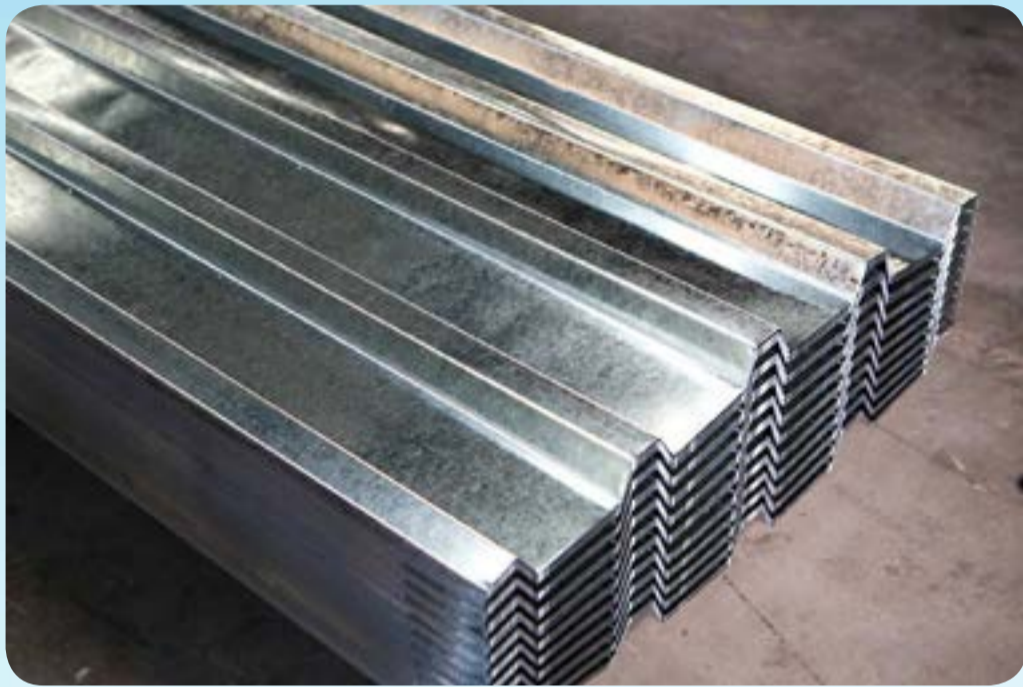



Specifications

Shape: Trapezoidal / Wavy

Width: 750-1250 mm

Thickness: 0.12-6.0 mm

Standard: ISO, JIS, ASTM, AS, EN

Base steel: Galvanized steel/Galvalume steel/PPGI/PPGL

Classification of Roofing Sheet



Trapezoidal steel sheet



Wavy steel sheet

Application

The corrugated metal is a good building material, mainly used for guardrail, floor and other buildings, such as airport terminal, railway station, stadium, concert hall, grand theatre, etc. According to different application requirements, the profiled steel sheet can be pressed into a wave type, a T type, a V type, a rib type and the like.





Guide For Ordering Products

- 01.Product designation
- 02.Product standard number
- 03.Grade
- 04.Product specification and size accuracy (incl. thickness, width and length)
- 05.Edge status
- 06.Surface quality level
- 07.Flatness accuracy
- 08.Type, coating weight and surface treatment in case of coated products
- 09.Surface structure
- 10.Packing method
- 11.Application
- 12.Other special requirements

Sincere Service

- 1.We are ISO Verified Outstanding Manufacturer.
- 2.The third party inspection:SGS,BV,CE,COC,AI and other.
- 3.Flexible Payment:T/T,LC,O/A,CAD,DAP.
- 4.Sufficient Stock.
- 5.Quick Delivery Time,Long time price validity.
- 6.Tracking picture of transport:production,Quality inspection,loading pictures.
- 7.Rich experience Professional Sale Team.
- 8.Fast and safe transportation.





FAQ

Q:Can you send samples?

A:Of course, we can send samples to all parts of the world, our samples are free, but customers need to bear the courier costs.

Q:What product information do I need to provide?

A:You need to provide the grade, width, thickness, coating and the number of tons you need to purchase.

Q:What are the shipping ports?

A:Under normal circumstances, we ship from Shanghai, Tianjin, Qingdao, Ningbo ports, you can choose other ports according to your needs.

Q:About product prices?

A:Prices vary from period to period due to cyclical changes in the price of raw materials.

Q:What are the certifications for your products?

A:We have ISO 9001, SGS, EWC and other certifications.

Q:How long does your delivery time take?

A:In general, our delivery time is within 30-45 days, and may be delayed if the demand is extremely large or special circumstances occur.

Q:Can I go to your factory to visit?

A:Of course, we welcome customers from all over the world to visit our factory. However, some of the plants are not open to the public.

Q:Does the product have quality inspection before loading?

A:Of course, all our products are strictly tested for quality before packaging, and unqualified products will be destroyed.

Q:How to pack the products?

A:The inner layer has a waterproof paper outer layer with iron packaging and is fixed with a fumigation wooden pallet. It can effectively protect products from corrosion during ocean transportation.

Q:What is your working time?

A:In general, our online service time is Beijing time: 8:00-22:00, after 22:00, we will reply to your inquiry during the next working day.

For more information, please contact us



Shanghai AIYIA Industrial Co., Ltd.

Contact Us

Email: info@aiyiaigroup.com

Skype: sunanwind88

WeChat: AIYIA668

QQ: 3004729276

Tel: 0086(021)63768818

Whatsapp: 8618221862128

Web: <https://aiyiaigroup.com/>

Address: Liqin Building, 1885 Duhui Road, Minhang District, Shanghai, China



Thank you!